

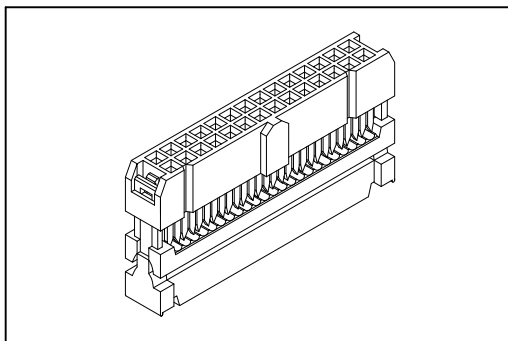

1001 Series

I.D.C. Socket 2.54mmX2.54mm(0.100"X0.100")



Material:

Housing: Thermoplastic Polyester Glass Filled UL94V-0.

Contacts: Copper Alloy.

Cable: 1.27mm (0.050") pitch flat cable.

Electrical Characteristics:

Current Rating: 1 A.

Dielectric Withstanding Voltage: AC 500V.

Insulator Resistance: 1000MΩ min.

Contact Resistance: 30mΩ max.

Operating Temperature: -40°C~+105°C.

Features:

- * Optional polarizing key, polarizing bump.
- * Optional strain relief.
- * Choices of gold plated or selective gold plated.

Mates with: 2011,2012,3011,3012,3016,3017.

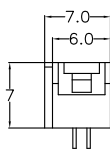
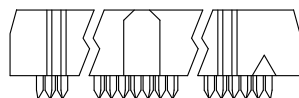
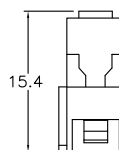
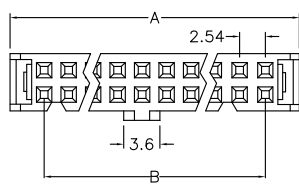
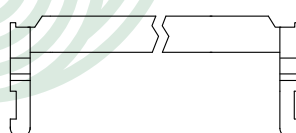
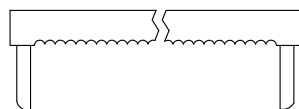
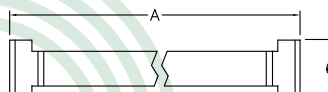
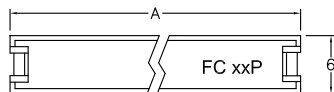

Position	Dimension		
	A	B	C
6	12.18	5.08	1.9
8	14.72	7.62	1.9
10	17.26	10.16	3.6
12	19.80	12.70	3.6
14	22.34	15.24	3.6
16	24.88	17.78	3.6
18	27.42	20.32	3.6
20	29.96	22.86	3.6
24	35.04	27.94	3.6
28	37.58	30.48	3.6
30	42.66	35.56	3.6
34	47.74	40.64	3.6
40	55.36	48.26	3.6
50	68.06	60.96	3.6
60	80.74	73.66	3.6
64	85.82	78.74	3.6

Ordering information

1001- Series
10 No. of Pin Count
C C: Selective Gold Plated G: Gold Plated
00 00: G/F
B B: Black Y: Grey
1 1: With Strain Relief 2: Without Strain Relief
A A: Tray Package

* Polarizing key (1001-Key) order separately.

** 1001-10G00B1NB suffix NB to identify without polarizing bump.
Contact factory for additional pin count.

Information including designs, specifications and components may be changed or updated without notice.