

REV.	SPECIFICATION	ECN NO.	APPD.

Without Light Pipe & Heat Sink

Material:
Cage: Cu-Ni Alloy, 30~80u" Nickel Plated.
EMI Spring: Beryllium Copper, 30~80u" Nickel Plated.
Heat Sink: Aluminum.
Heat Sink Clip: Steel.
LightPipe: PC.
***RoHS Compliant**

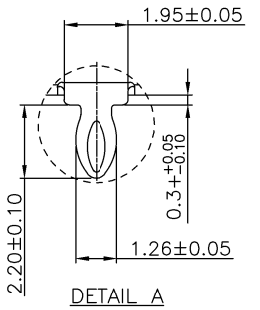
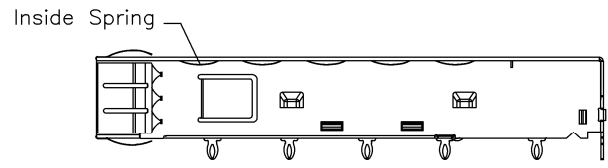
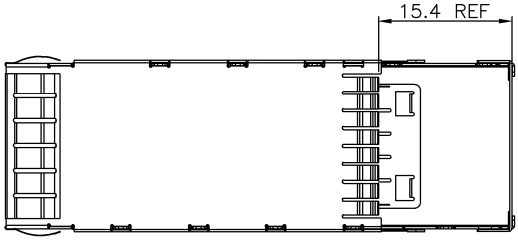
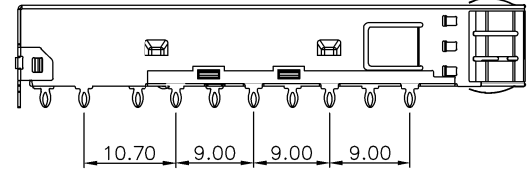
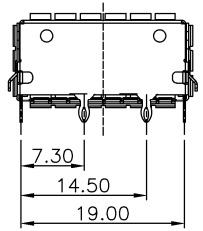
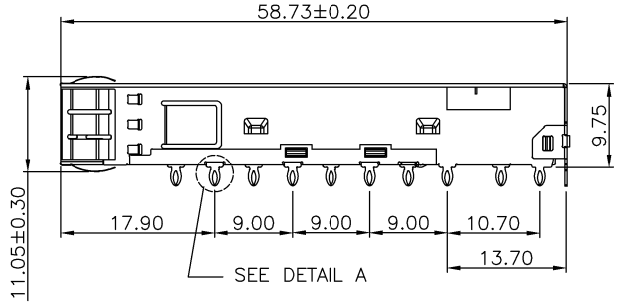
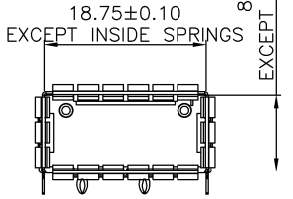
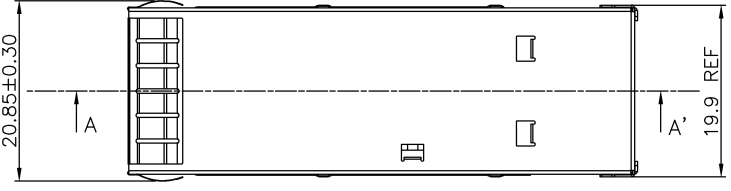
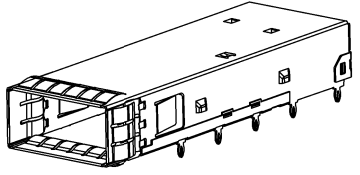

SECTION A-A'

8953-E 1 P P x A
 Series 1:1 Port P:Press Fit Type
 A:Tray Package
 0:Without Light Pipe & Heat Sink
 1:With Light Pipe & Heat Sink
 P:Spring Plus

Tolerances	Dwg. No.	8953D00001	Title:		 OUPIN ELECTRONIC(KUNSHAN) CO., LTD. P/N: 8953-E1PPxA
.x = ±0.25	Projection		8953-E Series		
.xx = ±0.13	Unit	mm	Scale	1:N	
.xxx = ±0.10	Drawn By	Martin 12/01'22	QSQP+ Cage With Heat Sink		
① 619					SHEET 1/4 Ver.No. A1

REV.	SPECIFICATION	ECN NO.	APPD.

With Light Pipe & Heat Sink

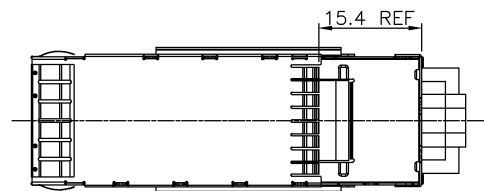
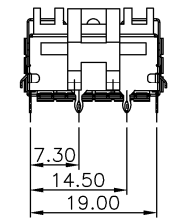
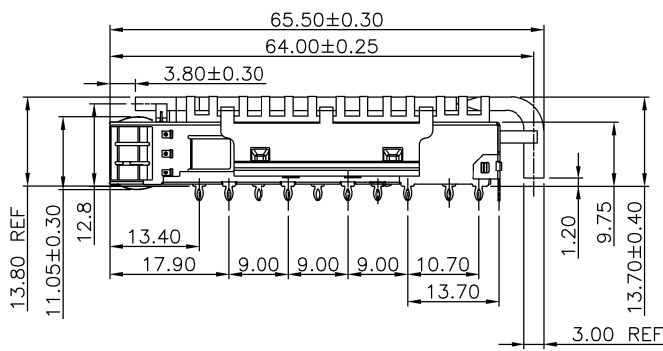
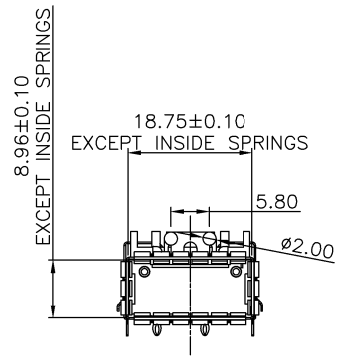
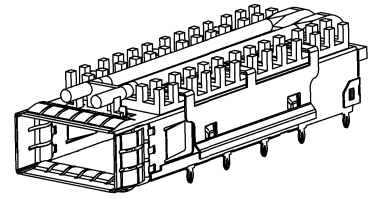
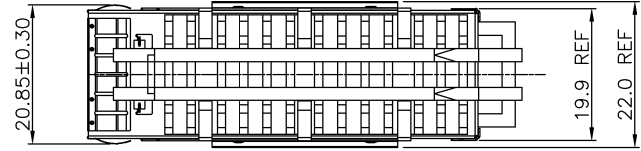

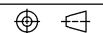
Tolerances	Dwg. No.	8953D00001		Title:		 OUPIIN ELECTRONIC(KUNSHAN) CO., LTD. P/N: 8953-E1PPxA SHEET 2/4 Ver.No. A1			
.x = ±0.25	Projection			8953-E Series					
.xx = ±0.13	Unit	mm	Scale	1:N					
.xxx = ±0.10	Drawn By	Martin 12/01'22		QSQP+ Cage With Heat Sink ① 619					

REV.	SPECIFICATION	ECN NO.	APPD.

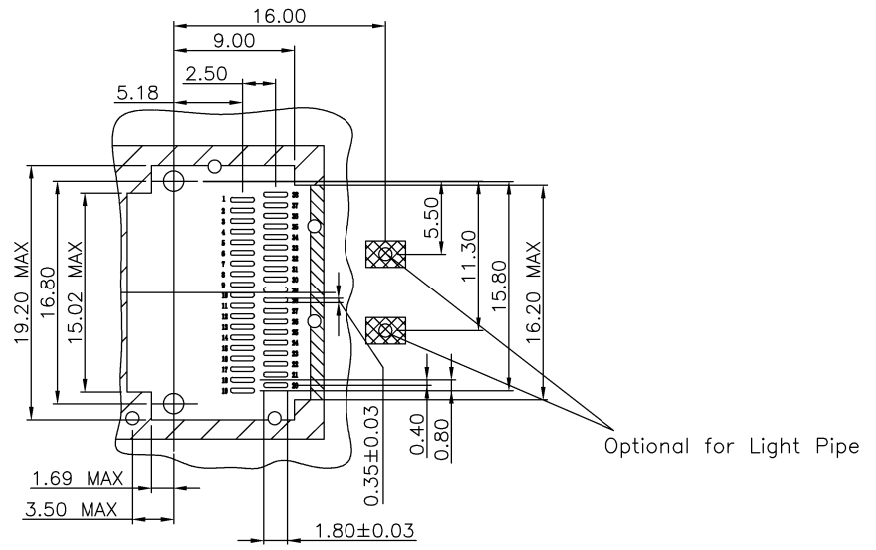
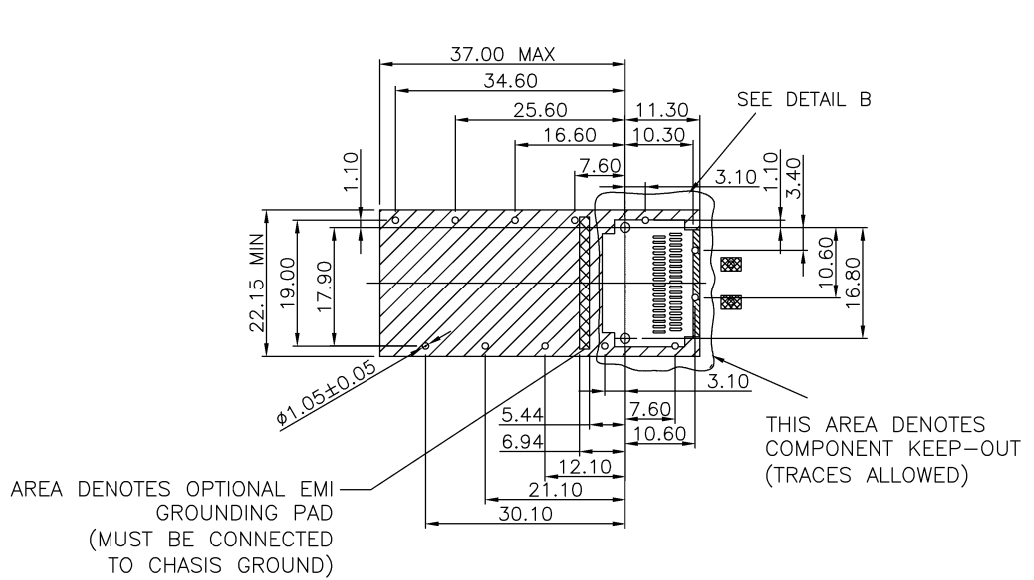

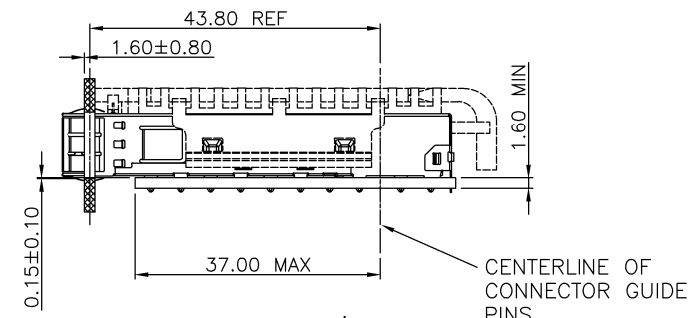
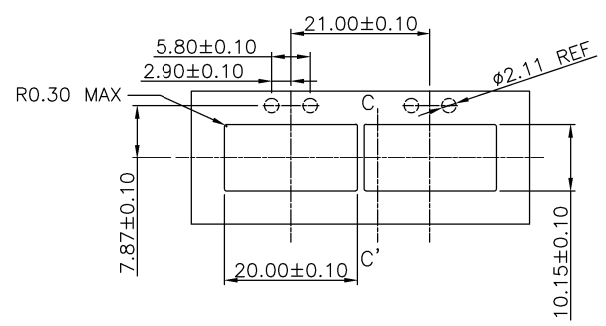

DETAIL B



SECTION C-C'

PCB LAYOUT FOR SINGLE SIDED APPLICATION

Tolerances	Dwg. No.	8953D00001	Title:		 OUPIN ELECTRONIC(KUNSHAN) CO., LTD. P/N: 8953-E1PPxA SHEET 3/4 Ver.No. A1
.x = ±0.25	Projection		8953-E Series		
.xx = ±0.13	Unit	mm	Scale	1:N	
.xxx = ±0.10	Drawn By	Martin 12/01'22	QSFPA Cage With Heat Sink		
<p style="text-align: center;">① 619</p>					

REV.	SPECIFICATION	ECN NO.	APPD.
------	---------------	---------	-------

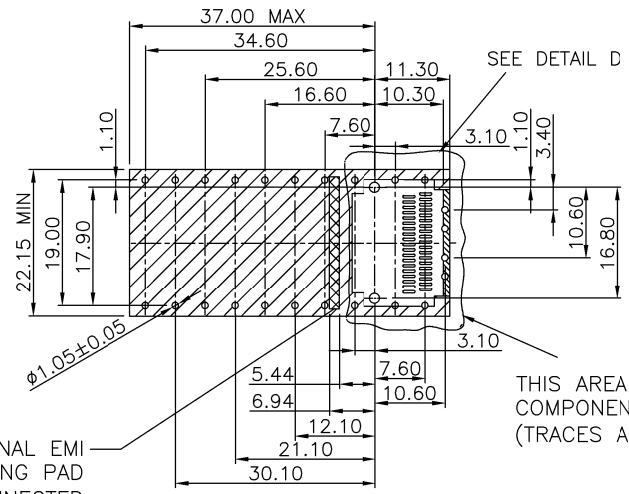

AREA DENOTES OPTIONAL EMI GROUNDING PAD (MUST BE CONNECTED TO CHASSIS GROUND)

THIS AREA DENOTES COMPONENT KEEP-OUT (TRACES ALLOWED)

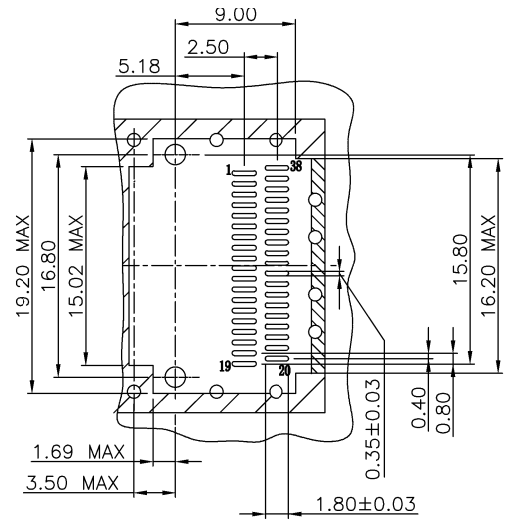

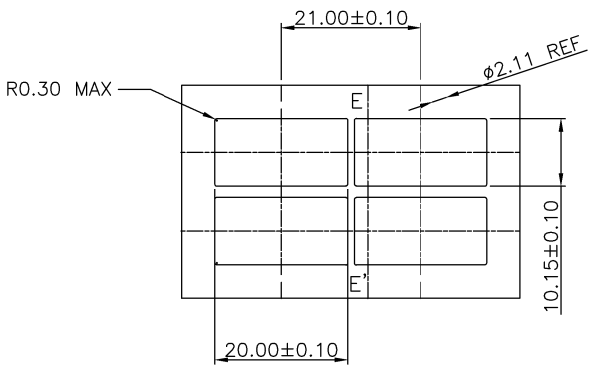

DETAIL D

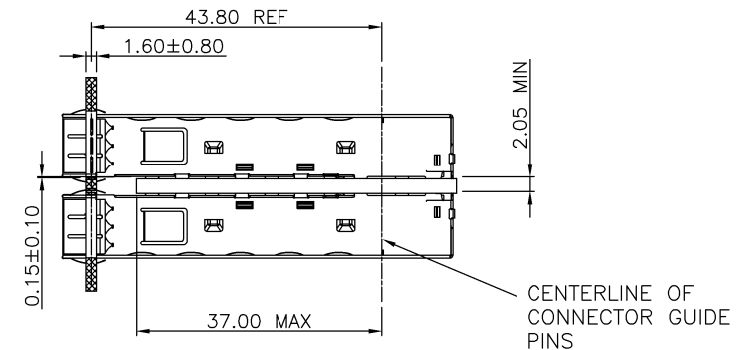

BEZEL CUTOUT LOCATIONS FOR BELLY FOR BELLY(ONLY WITHOUT LIGHT PIPE & HEAT SINK AVAILABLE)
APPLICATIONS ARE DEPENDENT ON PCB THICKNESS



SECTION E-E'

Tolerances	Dwg. No.	8953D00001	Title:		 DUPIN ELECTRONIC(KUNSHAN) CO., LTD. P/N: 8953-E1PPxA		
.x = ±0.25	Projection		8953-E Series				
.xx = ±0.13	Unit	mm	Scale	1:N			
.xxx = ±0.10	Drawn By	Martin 12/01'22	QSQP+ Cage With Heat Sink				
			① 619	SHEET	4/4	Ver.No.	A1