

REV.	SPECIFICATION	ECN NO.	APPD.

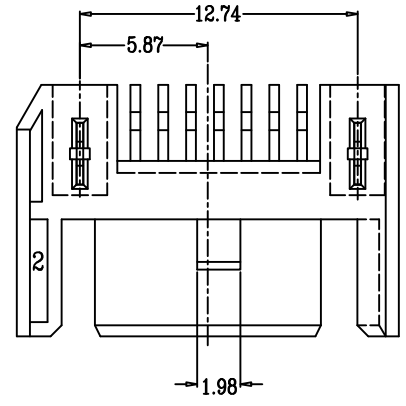
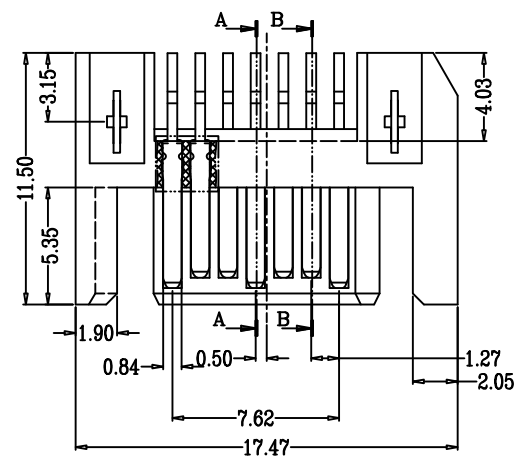

Material:
Housing: High Temperature Plastic UL94V-0.
Contacts: Copper Alloy.

Electrical Characteristics:
Current Rating: 1.5 AMP.
Dielectric Withstanding Voltage: 500 V AC.
Insulator Resistance: 1000MΩ min.
Contact Resistance: 30mΩ max.
Operating Temperature: -55°C ~ +125°C.

***RoHS Compliant**

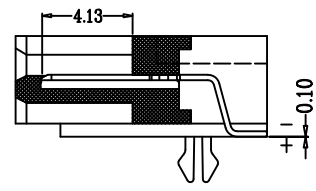
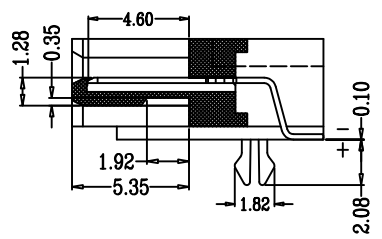
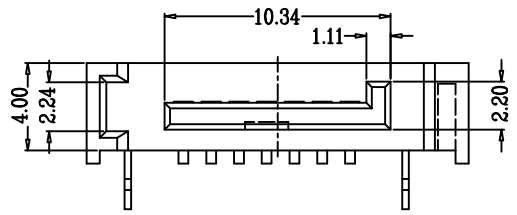

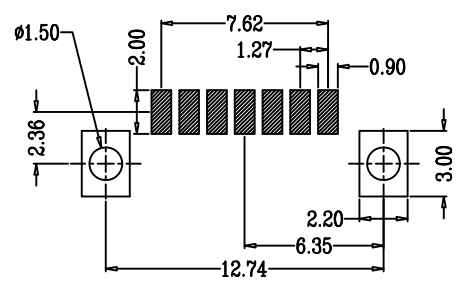

Sect A-A

Sect B-B



P.C. Board Layout

7904- 07 M C 15 D B U - 22
Series Position Male C:Selective 15:15u" D: SMD B:Black U:Tube Internal
Gold Plated Package Code

Tolerances	Dwg. No.	7904D01009	Title:		 OUPIIN ELECTRONIC(KUNSHAN) CO., LTD. P/N: 7904-07MC15DBU-22			
x = ±0.50	Projection		7904 Series Serial ATA 7P Right Angle Reverse SMD Type					
.x = ±0.38	Unit	mm	Scale	1:1	SHEET	1/1	Ver.No.	A1
.xx = ±0.25	Drawn By	Vic Lyu10/17'14		① 705				