

REV.	SPECIFICATION	ECN NO.	APPD.
X3			

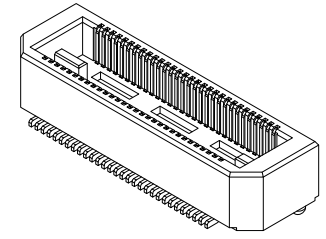

Material and Plating:
Housing: LCP, UL94V-0 , Black.
Signal Contacts :Phosphor Bronze.
Gold Plated on Contact Area and 80u" Min Tin Plated on Solder Tail over nickel 50u" Min .
Lock : Brass
80u" Min Tin Plated over nickel 50u" Min .

Electrical Characteristics:
Current Rating: Signal: 3A Per Contact With 3 Adjacent Contacts (UL).
Voltage Rating: 125V AC .
Dielectric Withstanding Voltage: 525V AC For 1 minute.
Insulator Resistance: 5000MΩ min at DC 500V.
Contact Resistance: 45mΩ max .
Operating Temperature: -55°C ~ +125°C .
***RoHS Compliant**

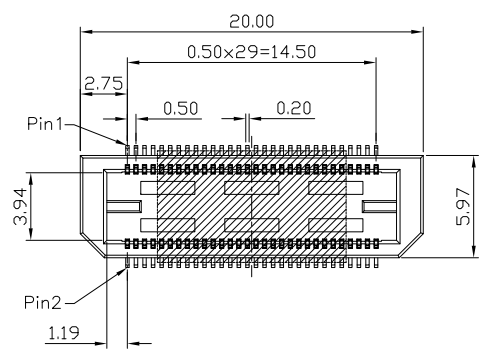
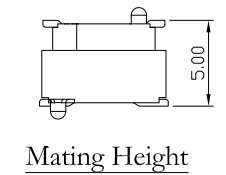
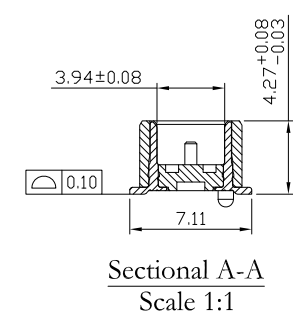
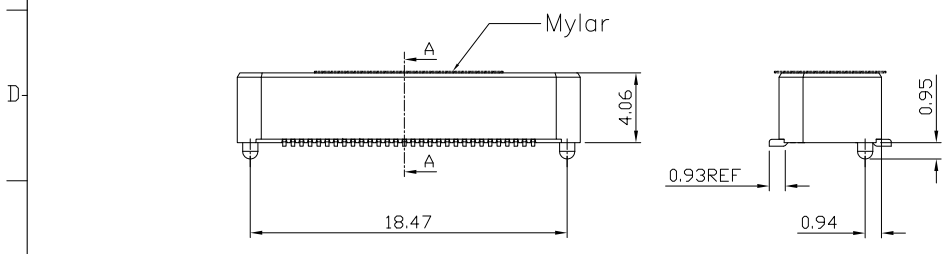

P: With Post Option Shown

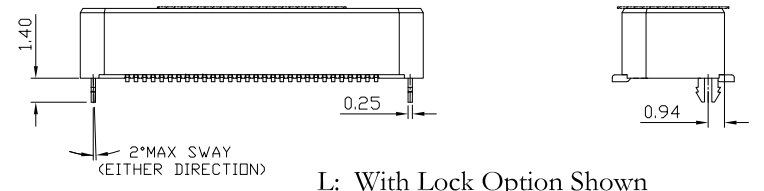

L: With Lock Option Shown

2336- 60 M C 3 D P 1 T -S

Series ————
Position ————
M: Male ————
C: Selective Gold Plated ————
1: G/F ————
3: 10μ" ————
7: 30μ" ————

S: Mylar
T: Tape & Reel Package
1: Code 1
N: W/O Post, W/O Lock
P: With Post, W/O Lock
L: W/O Post, With Lock
D: SMD Type

Tolerances	Dwg. No.	2336-D0000-002	Title:		2336 Series	OUPIN OUPIN ELECTRONIC(KUNSHAN) CO., LTD.
x = ±0.5	Projection		High Speed Board to Board		P/N: 2336-60MC3DP1T-S	
.x = ±0.25	Unit	mm	Scale	1:1	SHEET	1/2
.xx = ±0.15	Drawn By	WP 10/08'22	Pitch 0.5mm (Plug)		Ver.No.	X3

REV.	SPECIFICATION	ECN NO.	APPD.
X3			

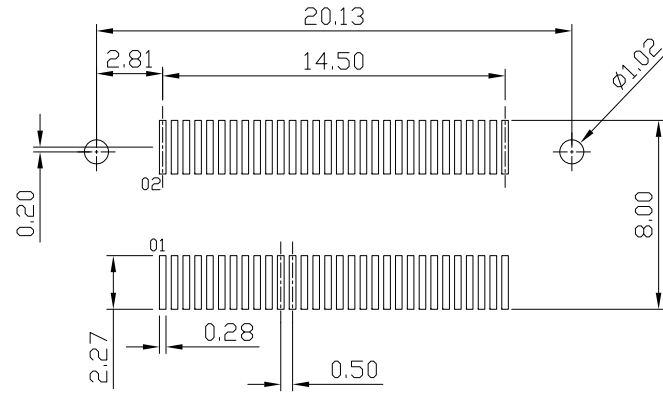

P.C.Board Layout For P Options
(Tolerance: ± 0.05)

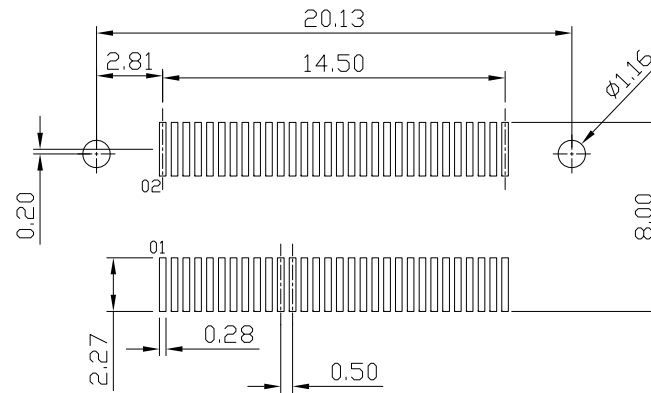

P.C.Board Layout For L Options
(Tolerance: ± 0.05)

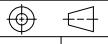
Tolerances	Dwg. No.	2336-D0000-002	Title:		 OUPIIN ELECTRONIC(KUNSHAN) CO., LTD. P/N: 2336-60MC3DP1T-S			
x = ± 0.5	Projection		2336 Series					
.x = ± 0.25	Unit	mm	Scale	1:1	High Speed Board to Board			
.xx = ± 0.15	Drawn By	WP 10/08'22	Pitch 0.5mm (Plug)		SHEET	2/2	Ver.No.	X3