

REV.	SPECIFICATION	ECN NO.	APPD.

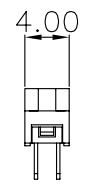

6111- xx C 00 B A
 Series No. of Pin Positions C: Selective Gold Plated 00: G/F B: Black A: Tray Package

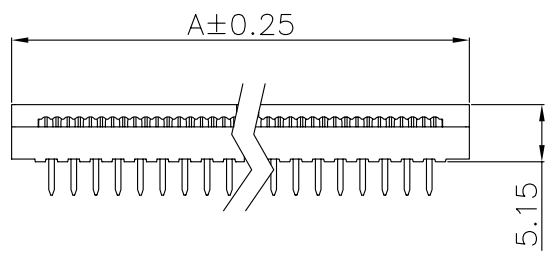
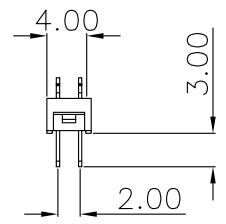
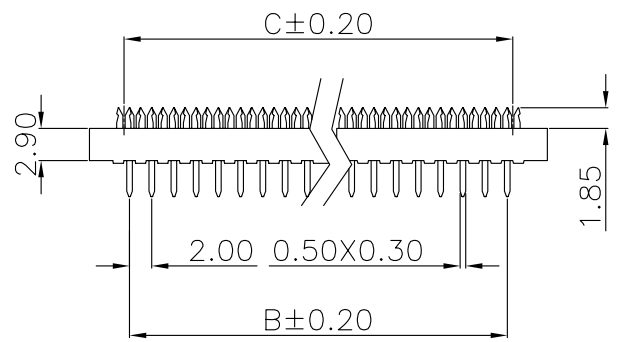
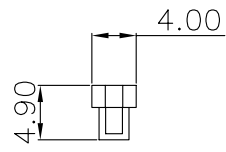
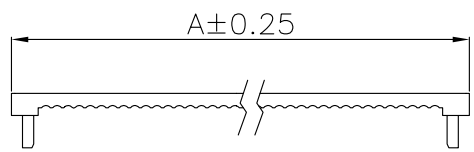
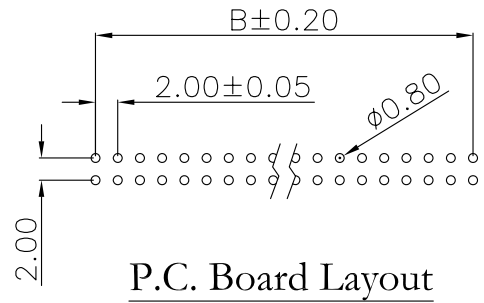

Position	6 Thru 68
Dimension	
A	2.0 X NO.of Positions/2+5.2
B	2.0 X NO.of Positions/2-2.0
C	2.0 X NO.of Positions/2-1.0

Tolerances	Dwg. No.	6111D01001
x = ±0.5	Projection	
.x = ±0.25	Unit	mm
.xx = ±0.15	Scale	1:1
	Drawn By	ZJJ 08/21'12

Title: 6111 Series Transition Plug 2.00mm(0.079")

OUPIIN
 OUPIIN ELECTRONIC(KUNSHAN) CO., LTD.
 P/N: 6111-xxC00BA
 SHEET 1/1 Ver.No. B1

