

REV.	SPECIFICATION	ECN NO.	APPD.
A3			

Material

Terminal Material: Copper Alloy(0.3mm Thickness).

Terminal Plating: Tin Plated.

Recommend Wire: 18AWG to 20AWG.

***RoHS Compliant**

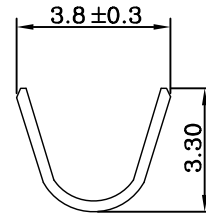
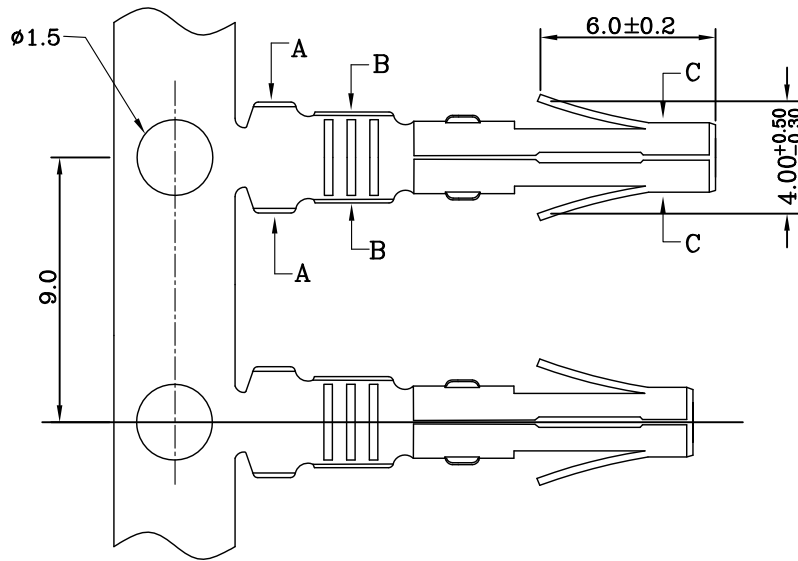

Section A-A

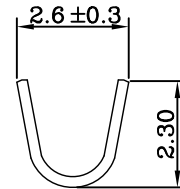

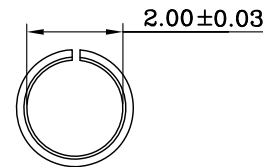
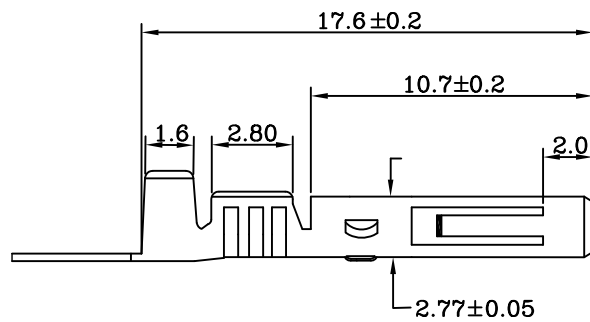

Section B-B



Section C-C

4874- PIN - F- 7K
Series F:Female 7K:Pins Per Reel

Tolerances	Dwg. No.	4874P02001	Title:		 OUPIIN ELECTRONIC(KUNSHAN) CO., LTD. P/N: 4874-PIN-F-7K SHEET 1/1 Ver.No. A4
x = ± 0.35	Projection		4874 Series		
.x = ± 0.25	Unit	mm	Scale	1:1	
.xx = ± 0.15	Drawn By	Vic Lyu11/12'14	Female Terminal		
			① 704		