

REV.	SPECIFICATION	ECN NO.	APPD.

**Material:**  
Housing: PA66, UL94V-2.  
**\*RoHS Compliant**

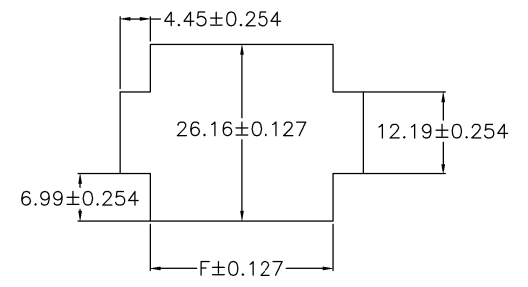
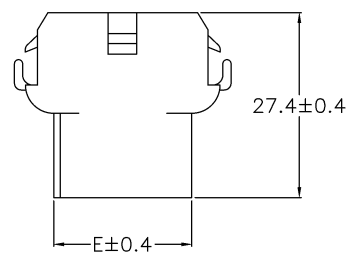
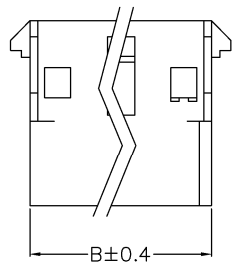
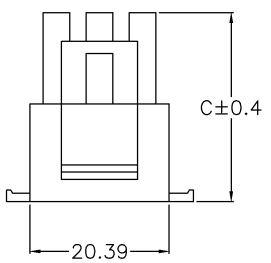
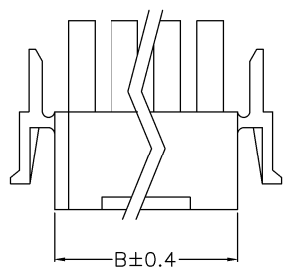
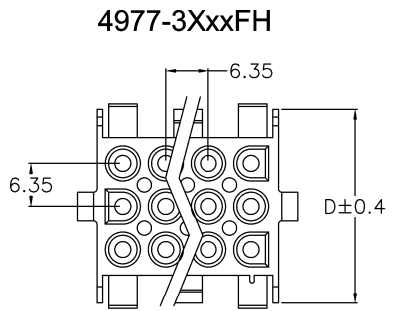
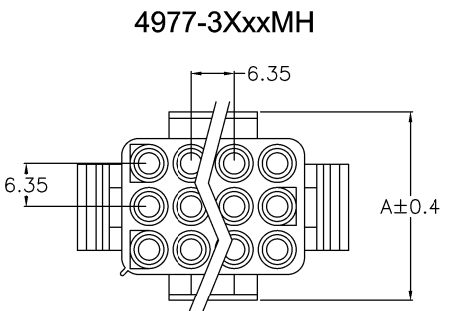

Panel must be punched so that housing enters panel in same direction as the punch.

4977- 3 X xx M H B  
Series Triple Row No. of Pin Per Row M:Male H: Housing B: Bulk Package  
F:Female

Position	Dimension						
	A	B		C	D	E	F
		Male	Female				
3X02	27.7	13.97	27.8	28.65	20.32	14.35	
3X03	27.7	20.5	27.8	28.70	20.50	20.70	
3X04	27.7	26.67	26.9	27.8	28.80	20.50	27.05
3X05	27.7	33.02	33.02	27.8	28.65	20.32	33.4

Tolerances	Dwg. No.	4977D03004	Title:	4977 Series 6.35mm Housing		
x = ±0.5	Projection		 <b>DUPIN ELECTRONIC(KUNSHAN) CO., LTD.</b> P/N: 4977-3XxxMHB&4977-3XxxFHB			
.x = ±0.4	Unit	mm			Scale	1:1
.xx = ±0.25	Drawn By	Martin 04/02'24			Ver.No.	A5

①667	SHEET	1/1	Ver.No.	A5
------	-------	-----	---------	----