

REV.	SPECIFICATION	ECN NO.	APPD.
R3		ECN161013	

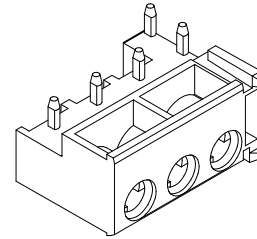
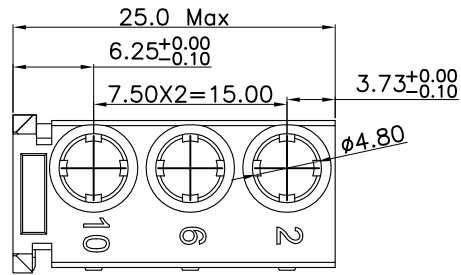

Material:

Housing: High Temperature Plastic UL94V-0.

Electrical Characteristics:

Operating Temperature: -55°C ~+125°C .

***RoHS Compliant**

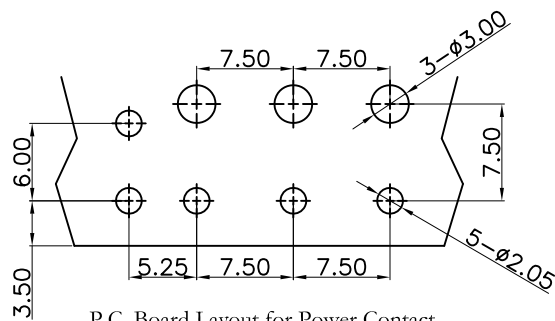
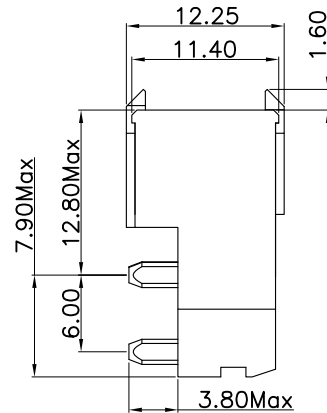
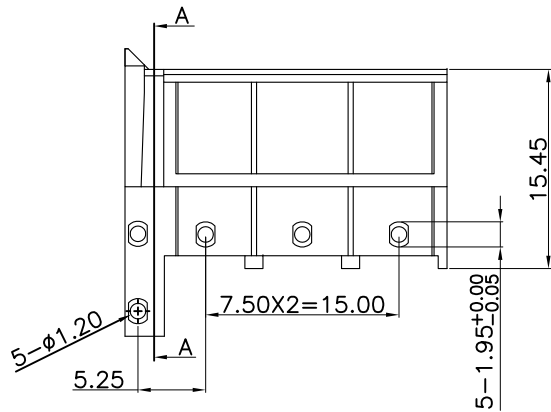

P.C. Board Layout for Power Contact

Tolerance±0.05
(Top View)

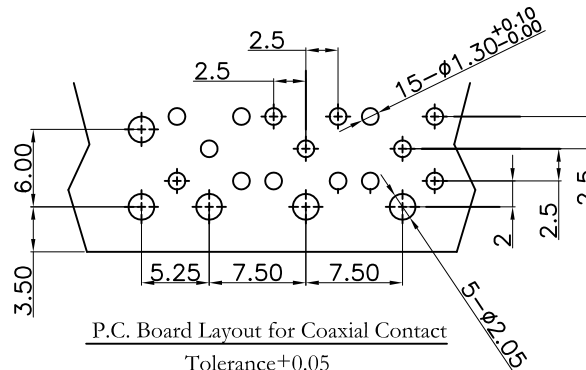

P.C. Board Layout for Coaxial Contact

Tolerance±0.05
(Top View)

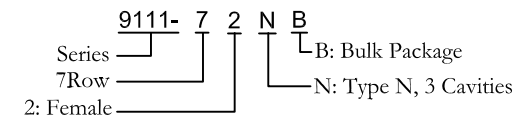

Tolerances	Drawn No.	9111D72009		Title:	
x = ±0.5	Projection	⊕		9111 Series	
.x = ±0.25	Unit	mm	Scale	H.D.METRIC	
.xx = ±0.15	Drawn By	LQ 10/12'16		Housing	

Title:			
9111 Series			
H.D.METRIC			
Housing			

OUPIN			
OUPIN ELECTRONIC(KUNSHAN) CO., LTD.			
P/N: 9111-72NB			
SHEET	1/1	Ver.No.	R3