

REV.	SPECIFICATION	ECN NO.	APPD.
R4		ECN150604	

Material:
Housing: Thermoplastic Polyester Glass Filled UL94V-0.
Contacts: Copper Alloy

Electrical Characteristics:
Current Rating: 2 AMP.
Dielectric Withstanding Voltage: AC 1000V For 1 Minute.
Insulator Resistance: 1000MΩ min. at DC 500V.
Contact Resistance: 20mΩ max. at DC 100mA.
Operating Temperature: -40°C~+105°C.
*RoHS Compliant

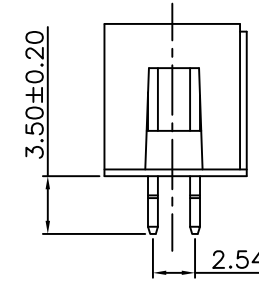
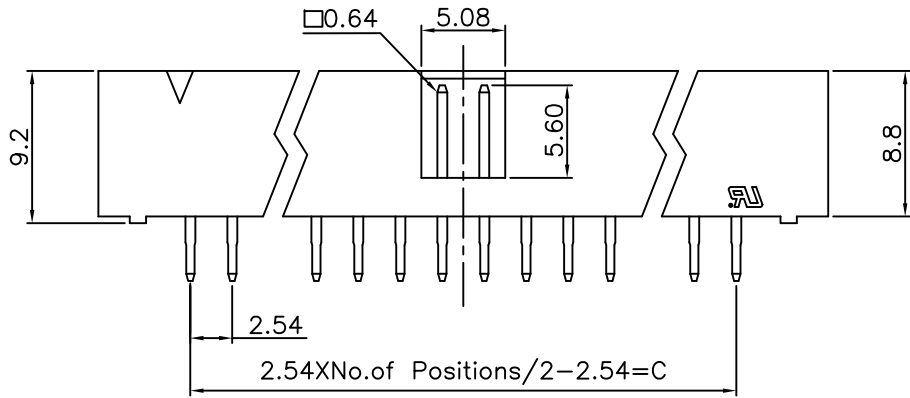
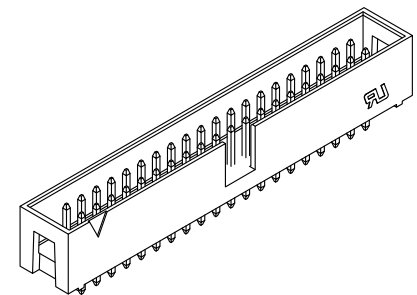
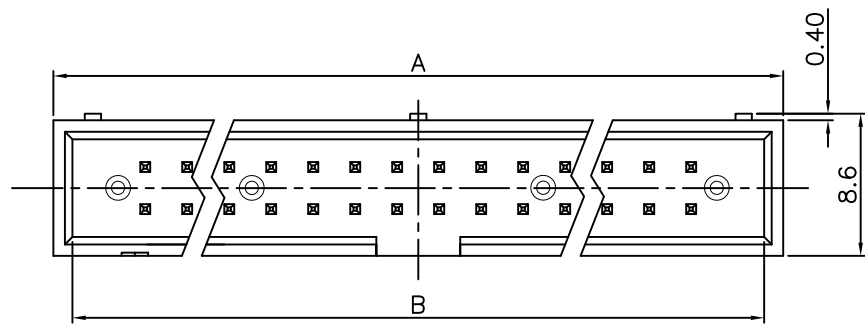

Straight Type

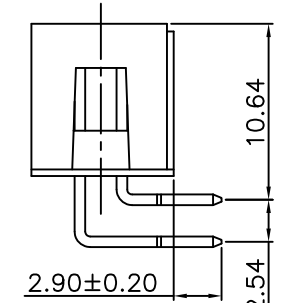

Right Angle Type

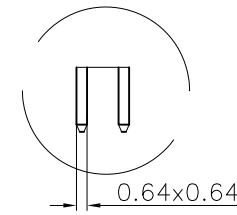

Straight Type
Detail A
Scale 1:1

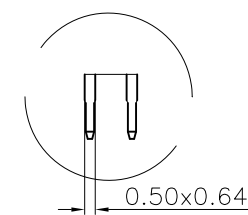

Right Type
Detail A
Scale 1:1

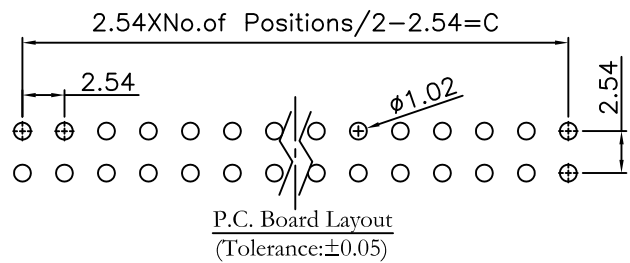

3012- xx C xx S B A
Series ———
No. of Pin Count ———
C: Selective Gold Plated ———
T: Tin Plated ———
00: G/F ———
10: 10μ" ———
15: 15μ" ———
30: 30μ" ———
————— Tray Package
————— B: Black
————— Y: Grey
————— S: Straight
————— R: Right Angle

Position	Dimension		
	A	B	C±0.10
10	20.34	18.10	10.16
14	25.48	23.18	15.24
16	27.90	25.72	17.78
20	33.05	30.80	22.86
26	40.68	38.42	30.48
30	45.70	43.50	35.56
34	50.80	48.58	40.64
40	58.46	56.20	48.26

Tolerances	Dwg. No.	3012D01019	Title:	 OUPIIN ELECTRONIC(KUNSHAN) CO., LTD. P/N: 3012-xxCxxSBA SHEET 1/2 Ver.No. R4			
x = ±0.5	Projection		3012 Series				
.x = ±0.25	Unit	mm	Box Header 2.54mm				
.xx = ±0.15	Drawn By	YY 09/06'15					

REV.	SPECIFICATION	ECN NO.	APPD.
R4		ECN150604	

Material:
Housing: Thermoplastic Polyester Glass Filled UL94V-0.
Contacts: Copper Alloy

Electrical Characteristics:
Current Rating: 2 AMP.
Dielectric Withstanding Voltage: AC 1000V For 1 Minute.
Insulator Resistance: 1000MΩ min. at DC 500V.
Contact Resistance: 20mΩ max. at DC 100mA.
Operating Temperature: -40°C~+105°C.
*RoHS Compliant

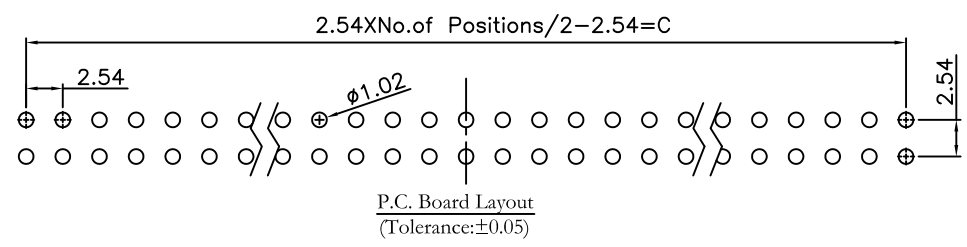
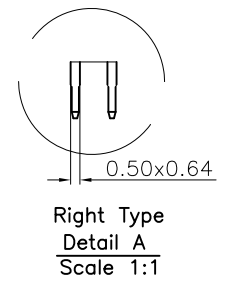
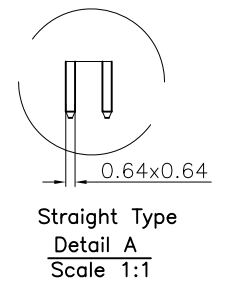
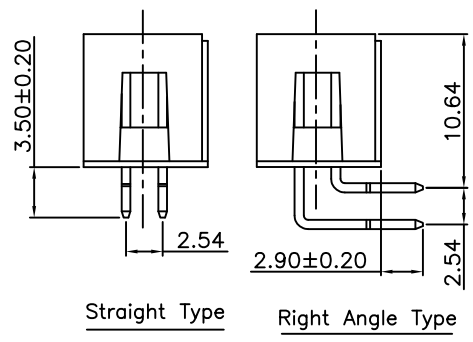
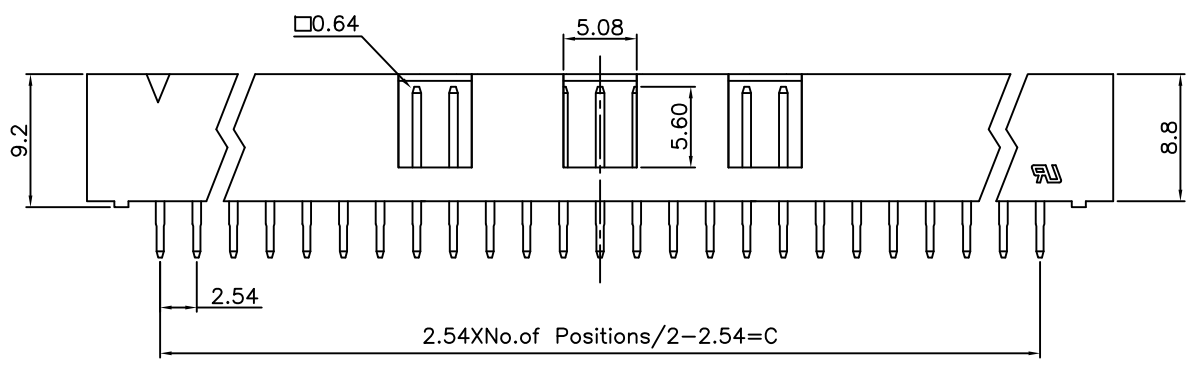
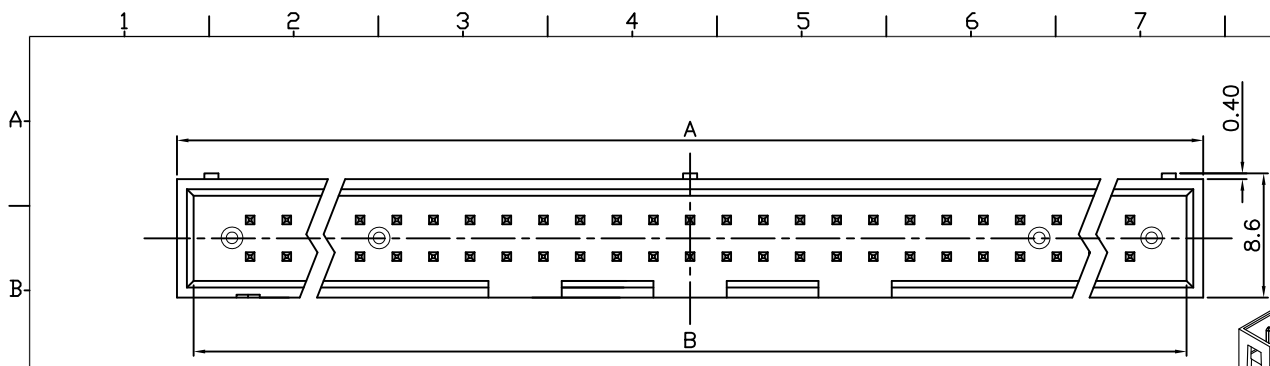
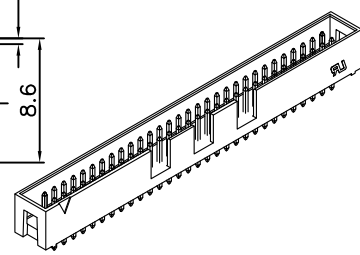

3012- xx C xx S B A
Series
No. of
Pin Count
C: Selective Gold Plated
T: Tin Plated
00: G/F
10: 10μ
15: 15μ
30: 30μ
Tray Package
B: Black
Y: Grey
S: Straight
R: Right Angle

Position	Dimension		
	A	B	C±0.10
50	71.10	68.90	60.96
60	83.80	81.60	73.66
64	89.10	86.68	78.74

Tolerances x = ±0.5 .x = ±0.25 .xx = ±0.15	Dwg. No.	3012D01019	Title: 3012 Series Box Header 2.54mm	 OUPIIN ELECTRONIC(KUNSHAN) CO., LTD.		
	Projection					
	Unit mm	Scale		1:1	SHEET	2/2
Drawn By	YY 09/06'15					